

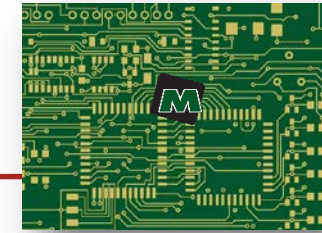

**VAPOURGUARD**

***STAGE 1 VAPOUR RECOVERY  
SAFEGUARD SYSTEM***



**Main board - receiver**  
designed & developed  
by Metricon

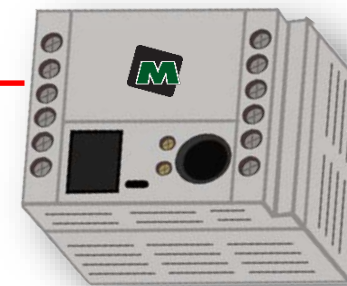

**Leakage Continuous  
Control System**  
designed & developed  
by Metricon

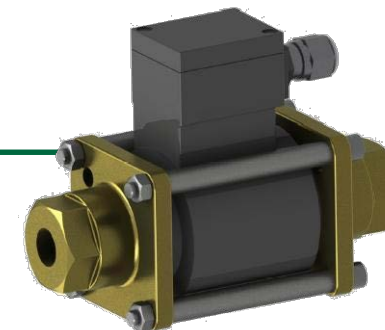

**Electrovalves**

### System Central Panel / Main buttons - functions

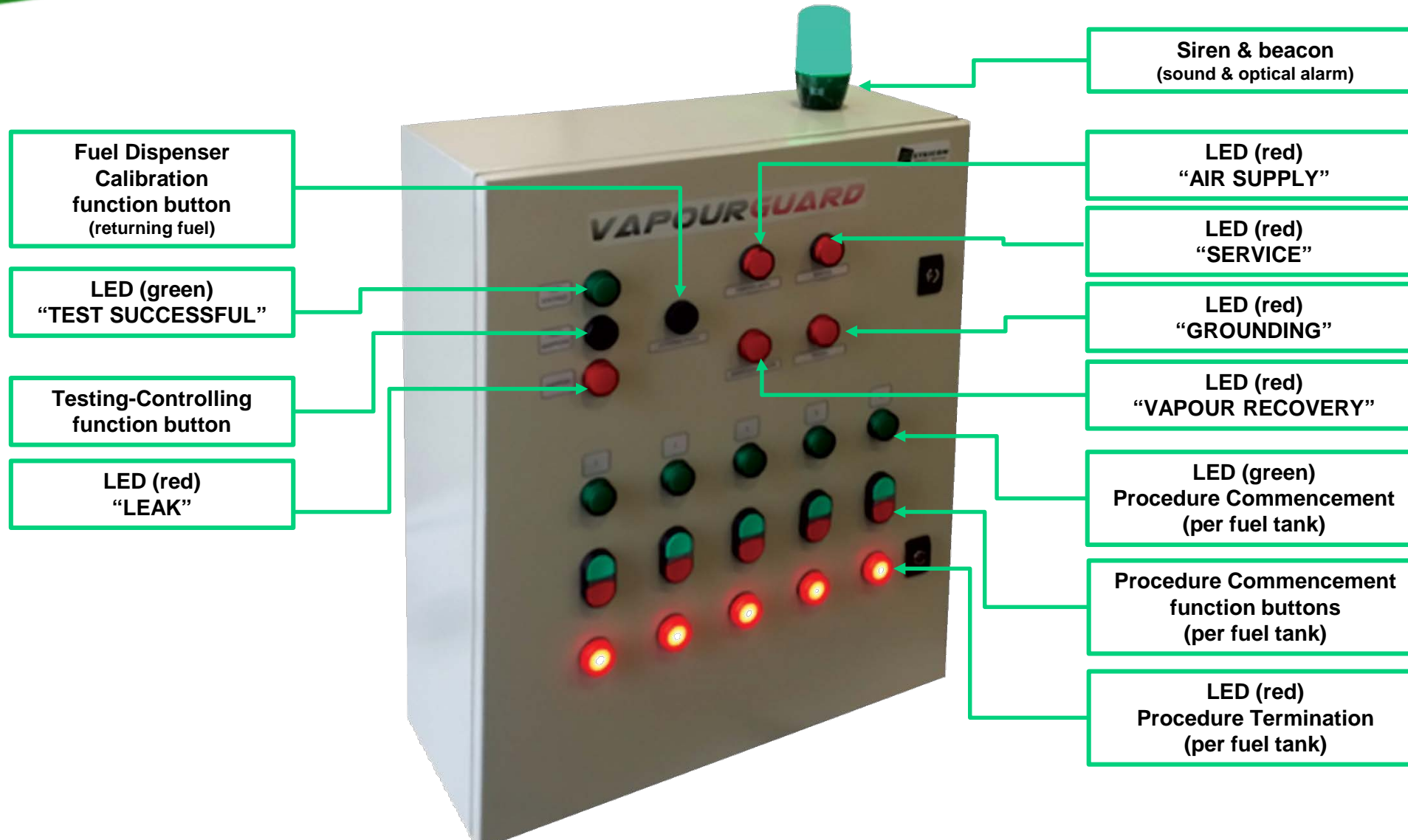

### Fuel tanker truck connection & Connection to fuel tanks

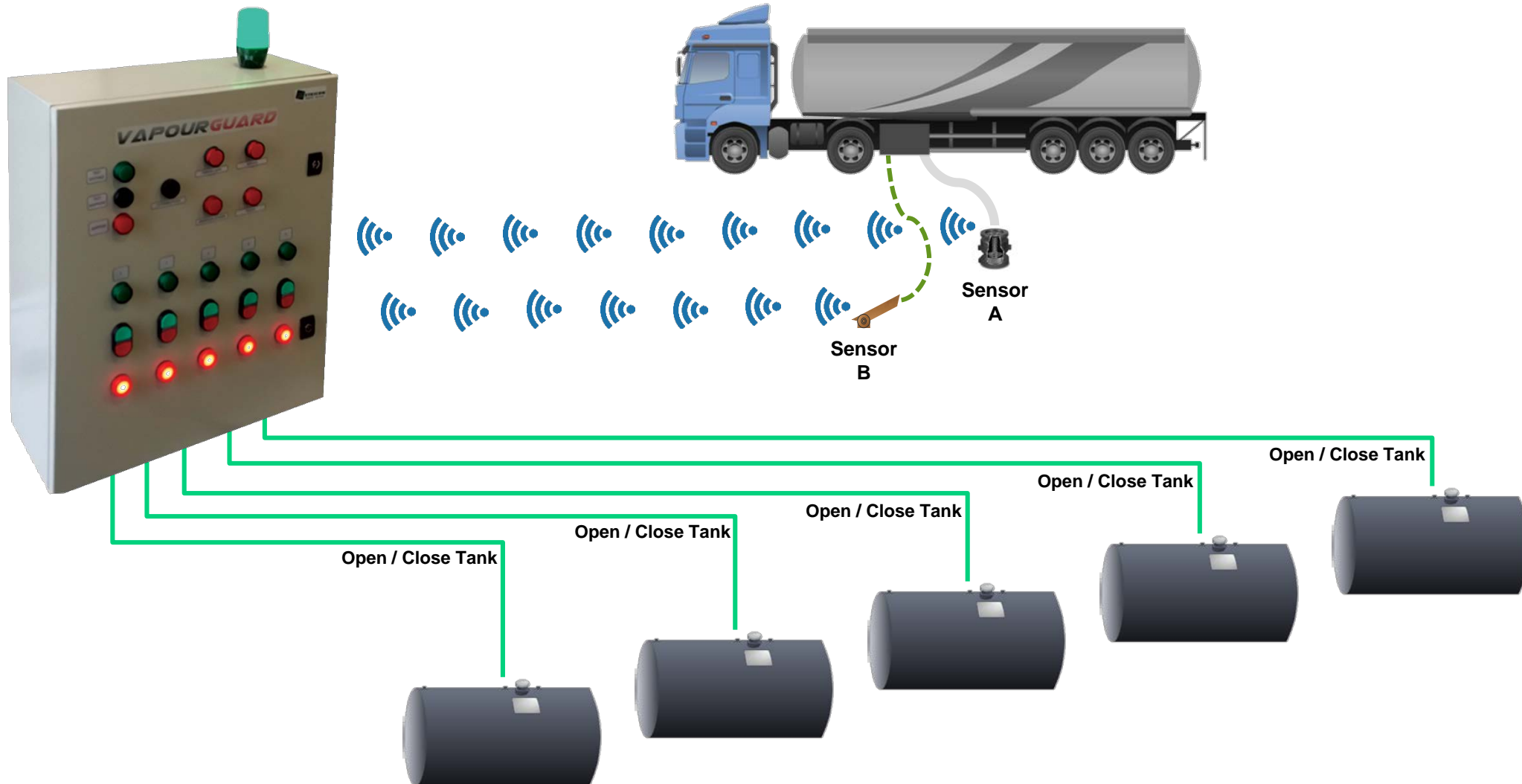

### Sensor A (layout)

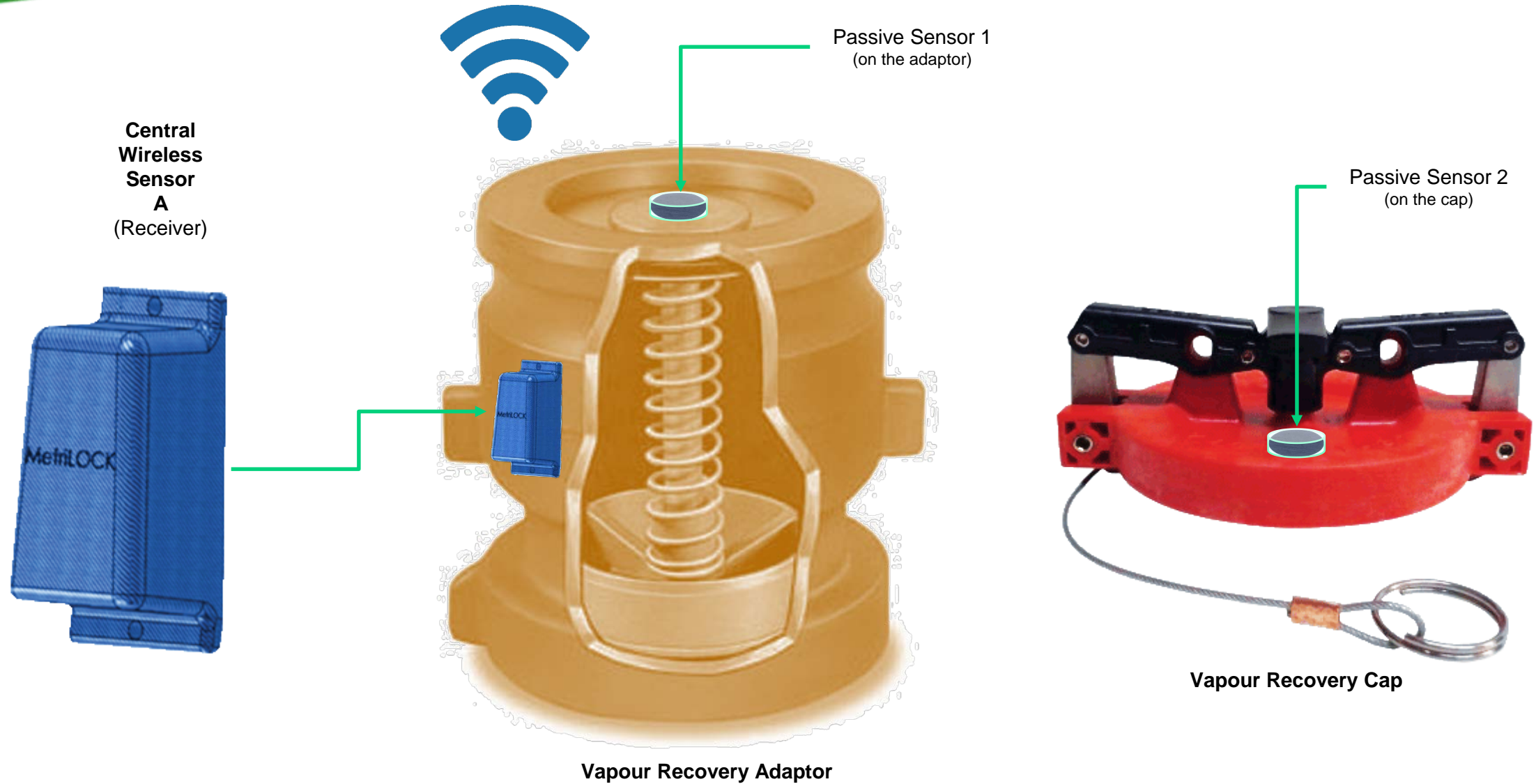

Sensor B (layout)



### Sensor B (layout)

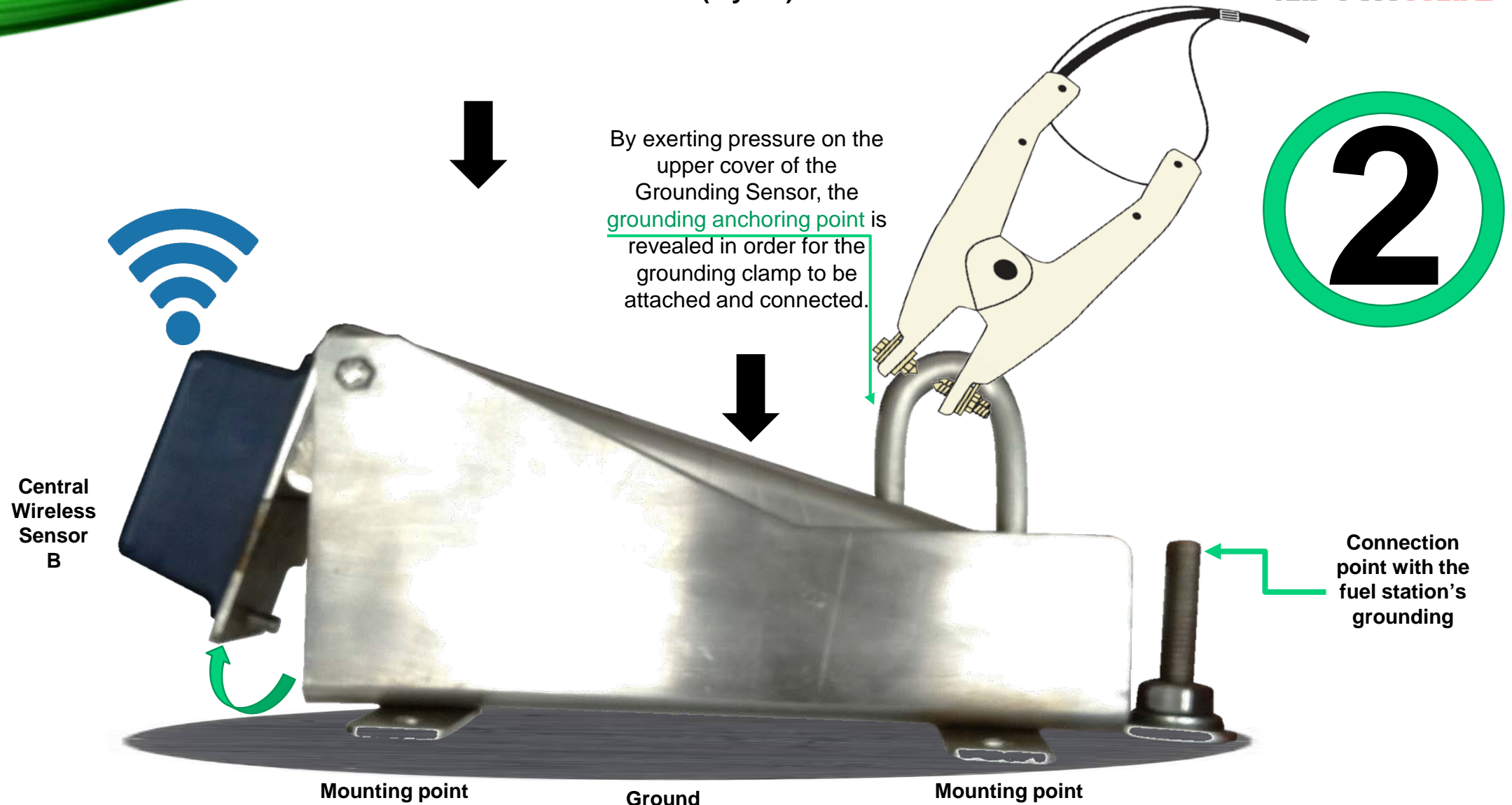

# **VAPOURGUARD**

***STAGE 1 VAPOUR RECOVERY***

***SAFEGUARD SYSTEM***



**redefine | accuracy**



65 ATHINON ROAD,  
AG. GEORGIOS RIO  
26504, PATRAS - GREECE  
T/F: +302610993002  
info@metricon.gr  
www.metricon.gr